



Full Color Panel

FilaSorb™ 12

acoufelt
making quiet

Product Detail

Application	Wall
Composition	100% polyester
Material	FilaSorb™
Recycled content	60% min
Dimensions	1220 x 2800mm Custom size available upon request
Thickness	12mm +/- 10%

Guarantees

Warranty against defects 20 years*
Light fastness warranty 20 years*

*conditions apply

QuickShip



Talk to our team on our QuickShip lead times

Technical Data

Fire rating	AS/ISO 9705.1, Group 1 ASTM E84-17a, Class A EN 13501-1: 2019, B-s1, d0
Indoor air quality	SCS-EC10.3-2014 v4.0 meeting standard CDPH/EHLB Standard Method v.1.2-2017, $\leq 0.5\text{mg}/\text{m}^3$
Light fastness	ISO 105-B02, 6-7

Sustainability



Made from 60% min. recycled content



Red List Free Declare Label

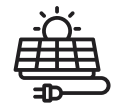

Generated using 40% solar energy



Recyclable at end-of-life



Total VOC's less than $0.5\text{mg}/\text{m}^3$ (3rd Party Verified)



Phenol & formaldehyde free



Acoustic Performance

Test method	ISO 354-2006
Results	NRC 0.45 (no air gap) NRC 0.54 (12mm air gap) NRC 0.64 (20mm air gap) NRC 0.85 (200mm air gap)

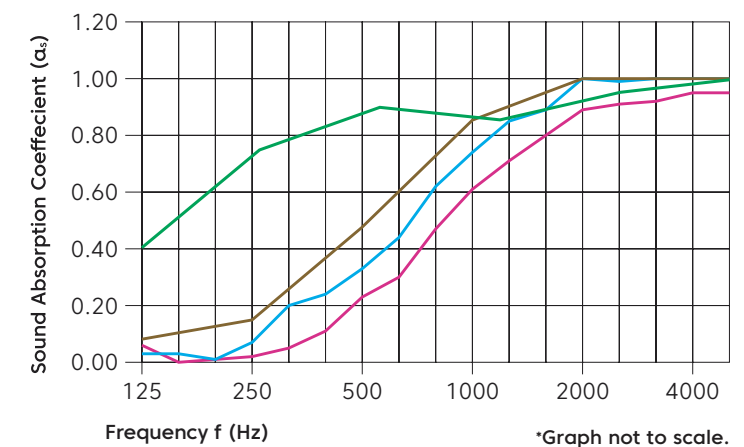

Frequency (Hz)	125	250	500	1000	2000	4000	NRC
α_s no air gap	0.06	0.02	0.23	0.61	0.89	0.95	0.45
α_s 12mm air gap	0.03	0.14	0.33	0.74	1.00	1.00	0.54
α_s 20mm air gap	0.05	0.16	0.48	0.85	1.00	1.00	0.64
α_s 200mm air gap	0.40	0.75	0.90	0.85	0.95	1.00	0.85

Colorways

Light Reflectance Values (LRV), are a measure of the percentage of visible and usable light that is reflected from a surface when illuminated by a light source.

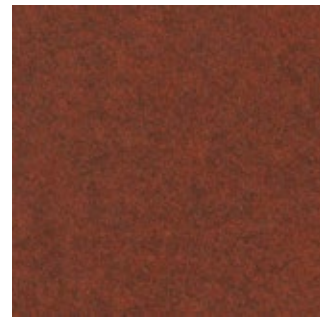

Peppercorn
LRV - 8.50%

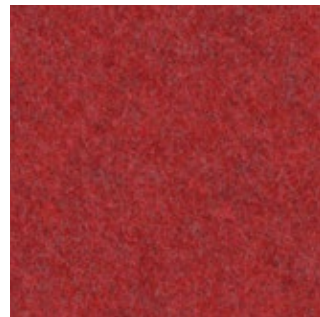

Currant
LRV - 7.04%

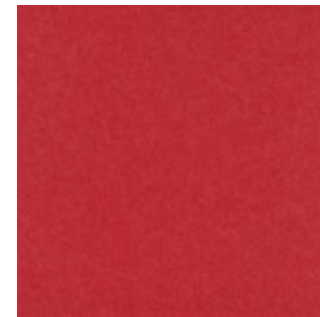

Lipstick Red
LRV - 12.50%

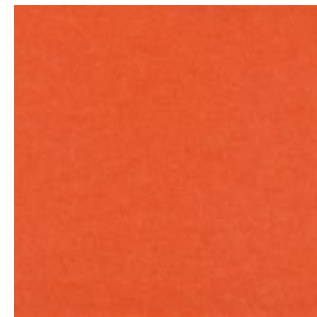

Carrot
LRV - 20.00%

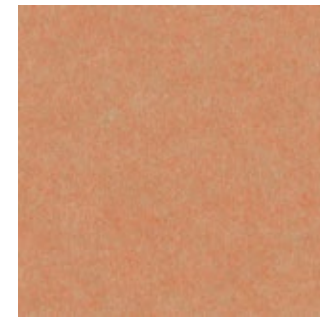

Peach
LRV - 29.00%

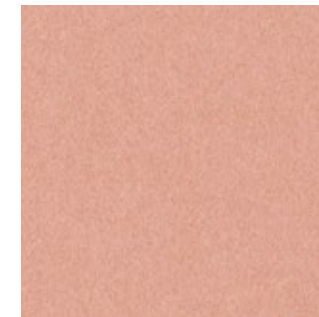

Flamingo
LRV - 37.54%

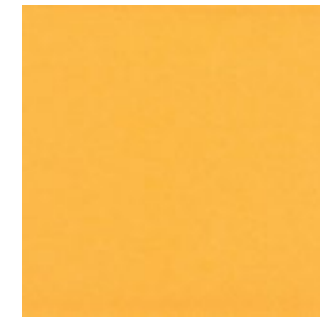

Butter
LRV - 62.00%

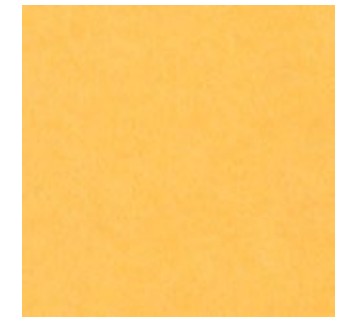

Popcorn
LRV - 65.00%

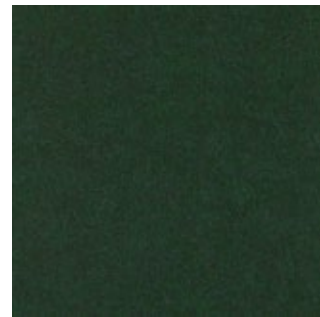

Kale
LRV - 4.50%

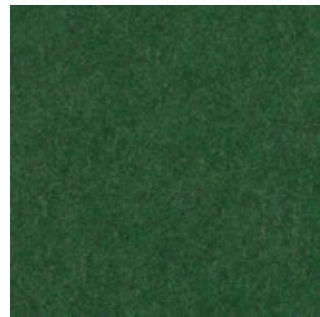

Oregano
LRV - 8.80%

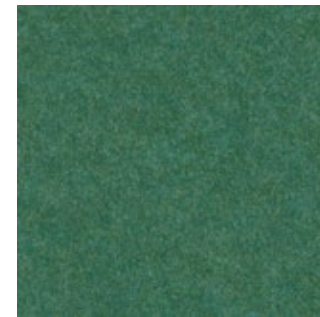

Thistle
LRV - 13.00%

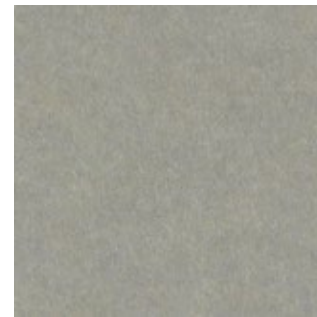

Pistachio
LRV - 30.00%

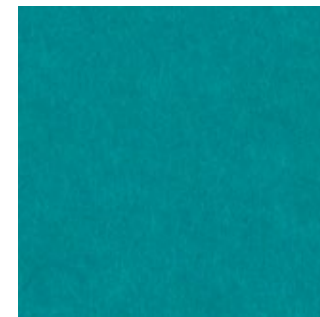

Peacock
LRV - 19.00%

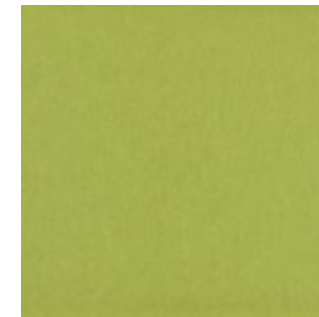

Wasabi
LRV - 38.00%

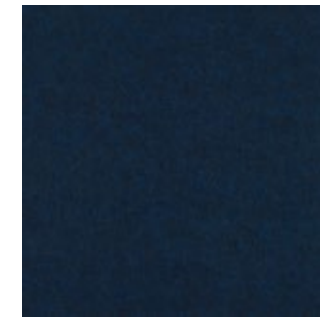

Midnight Blue
LRV - 3.50%



Denim
LRV - 6.00%

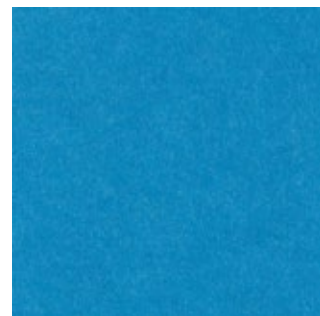

Azur
LRV - 18.00%

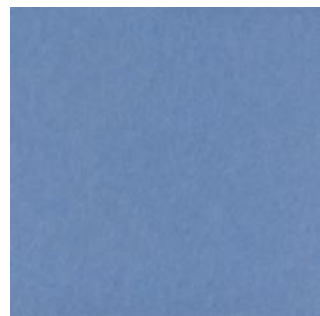

Marine
LRV - 25.00%



Periwinkle
LRV - 36.00%

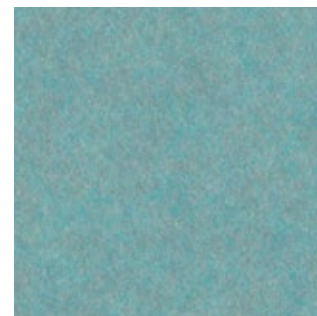

Sea Salt
LRV - 28.56%



Lilac
LRV - 39.00%

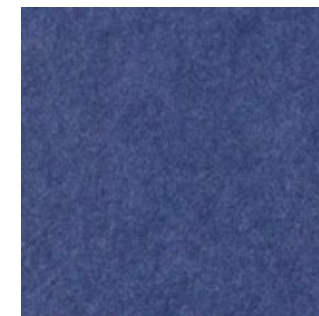

Iris
LRV - 10.50%

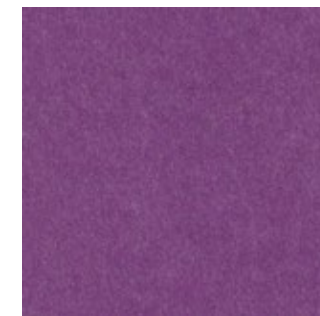

Berry
LRV - 12.00%



Pearl
LRV - 54.00%



Ivory
LVR - 40.00%



White
LRV - 83.22%



Piano Black
LRV - 3.00%



Charcoal
LRV - 5.46%



Slate
LRV - 12.50%



Grey
27.00%



Metal
LRV - 35.00%



Platinum
LRV - 42.00%

New Releases

Available Feb 2023



Sencha
LRV - 34.15%



Umber
LRV - 20.35%



Walnut
LRV - 12.14%

Available Mar 2023

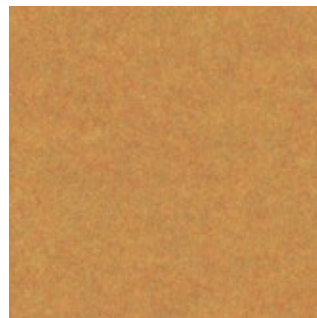

Turmeric
LRV - 29.59%



Granite
LRV - 6.40%



Almond
LRV - 53.64%

Mounting Methods

Adhesive Backing

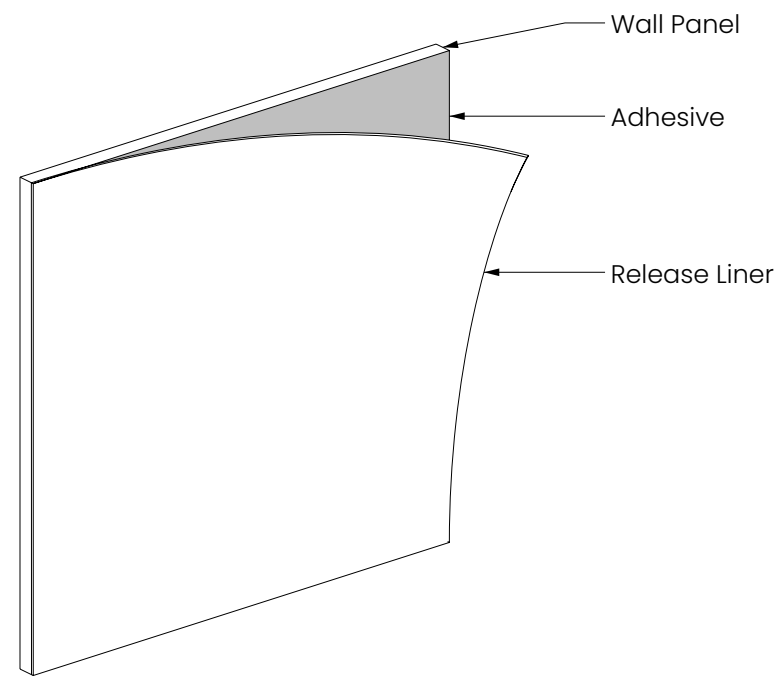

Constructive Adhesive

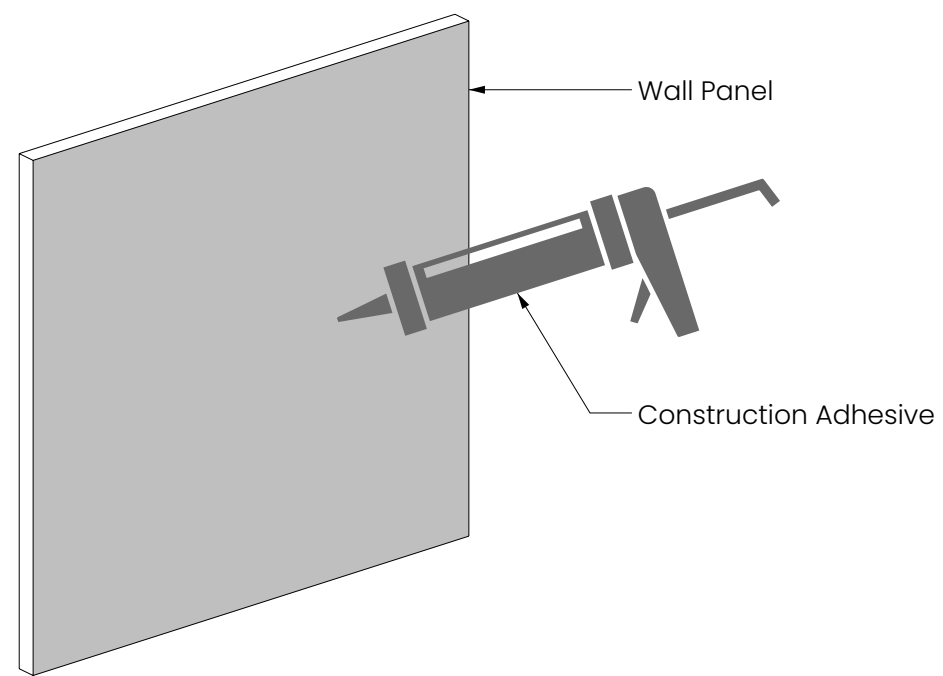

Pot Magnet Install

Wall Pot Magnet Install Metal Plate

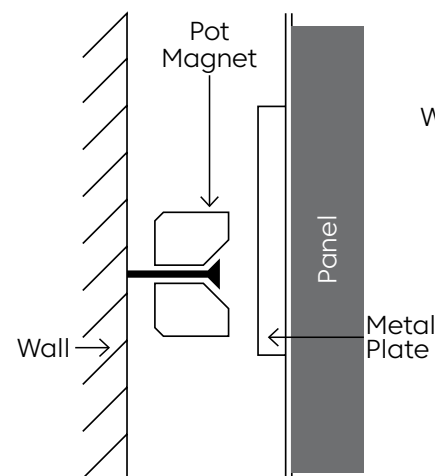

Wall Pot Magnet Install L Plate + Metal Plate

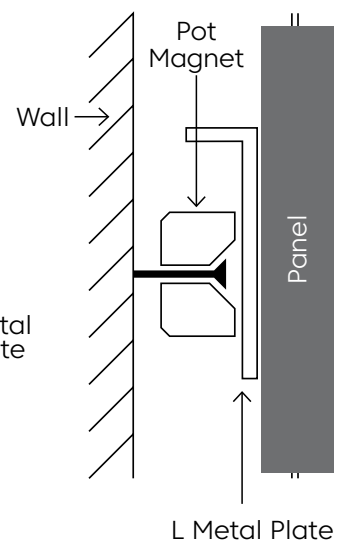

L Plate Wall + Metal Plate Configuration

○ L Metal Plate × Metal Plate

