

Full Color Panel

FilaSorb™ 22

acoufelt
making quiet

Product Detail

Product	Full Color
Application	Wall and ceiling
Composition	100% polyester
Material	FilaSorb™
Recycled Content	60% min
Dimensions	1220 x 2800mm Custom size available upon request
Thickness	22mm +/- 10%

Guarantees

Warranty against defects 20 years*
Light fastness warranty 20 years*

*conditions apply



QuickShip available



Technical Data

Indoor Air Quality	SCS-EC10.3-2014 v4.0 meeting standard CDPH/EHLB Standard Method v.1.2-2017, ≤ 0.5mg/m ³
Light Fastness	ISO 105-B02, 6-7
Fire Test Method	ASTM E84-18b, Class A

Environmental Attributes

- Every square meter of FilaSorb™ diverts on average approximately 108 x 600ml PET drinking bottles from landfill
- LBC Red list free
- Phenol & formaldehyde free
- Total VOC's 0.5 mg/m³
- CDPH compliance
- Complies with building standards



Made from 60% min. recycled content



Declare Living Building Challenge compliant



Generated using 40% solar energy



Recyclable at end-of-life



Declare.

Acoustic Performance

Sound Absorption ASTM C423-2017
 NRC 0.70 (no air gap)

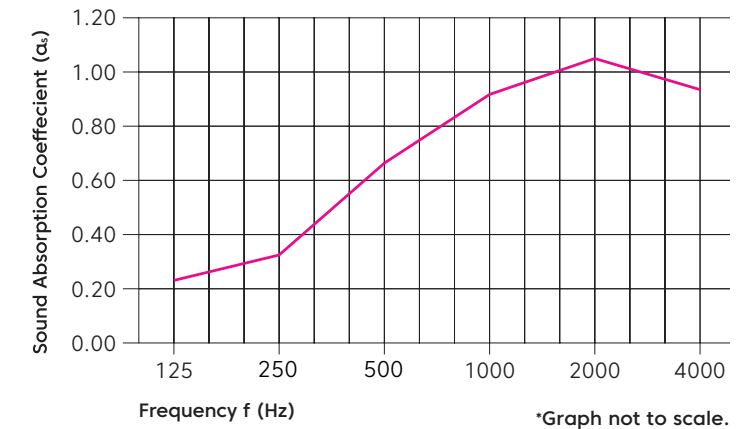

Frequency (Hz)	125	250	500	1000	2000	4000	NRC
α _s	0.23	0.35	0.67	0.93	1.06	0.94	0.70

Colorways



White



Piano Black



Light Grey

Mounting Methods

Adhesive Backing

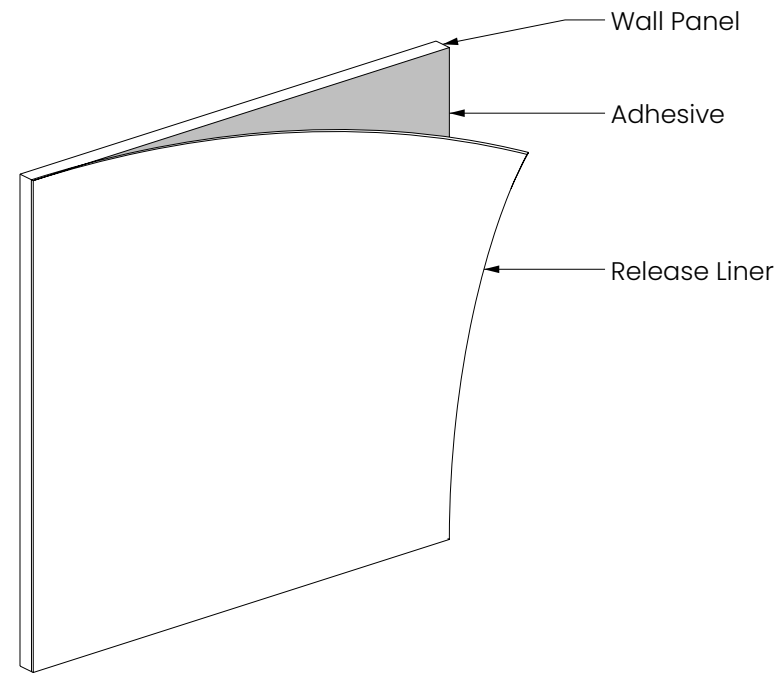

Constructive Adhesive

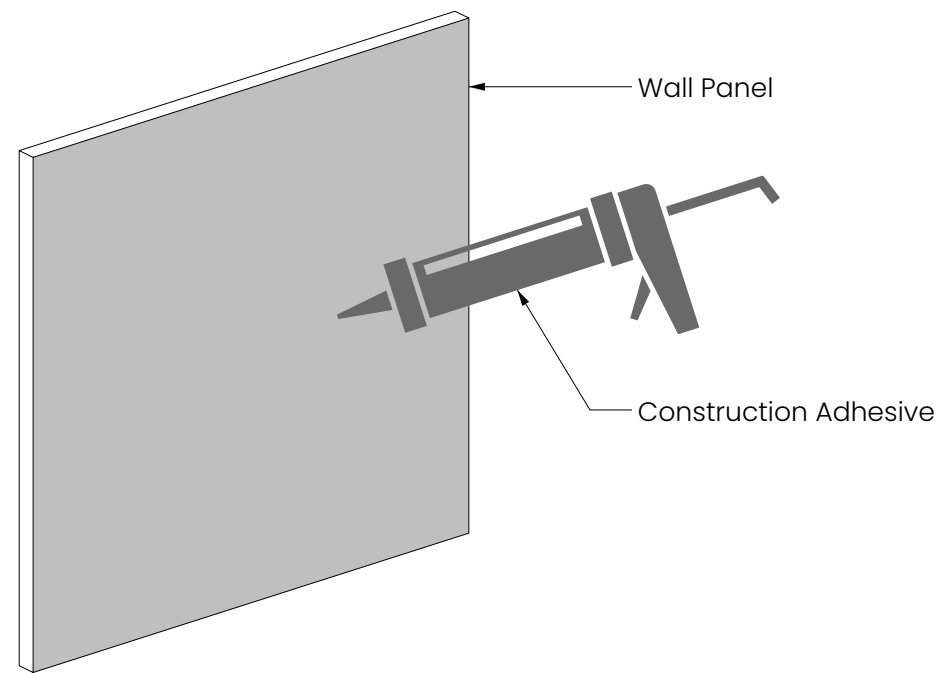

Z-Clip Mount

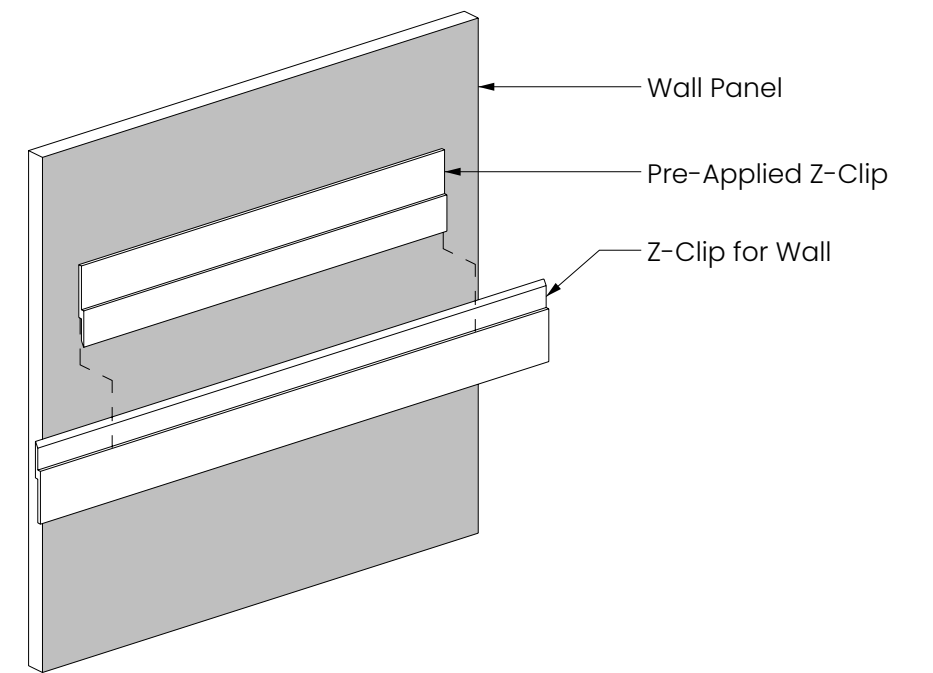

Pot Magnet Install

Wall Pot Magnet Install Metal Plate

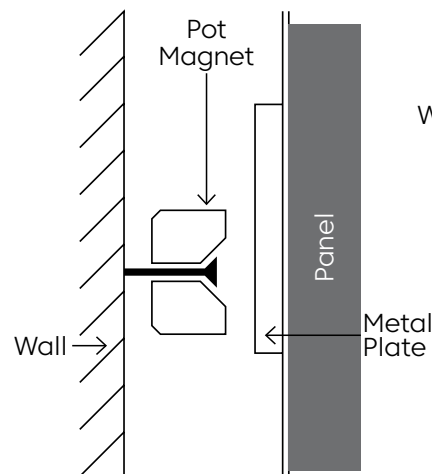

Wall Pot Magnet Install L Plate + Metal Plate

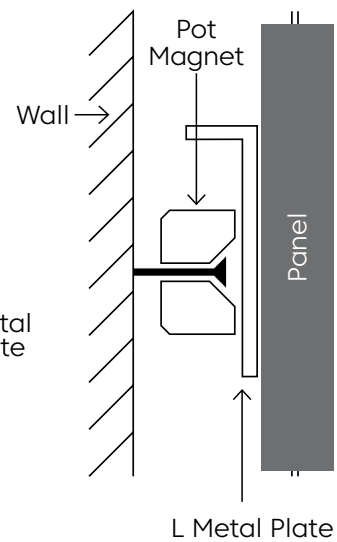

L Plate Wall + Metal Plate Configuration

○ L Metal Plate × Metal Plate

