



Pixel

FilaSorb™ 24

acoufelt
making quiet

Product Detail

Application	Wall
Composition	100% polyester
Material	FilaSorb™
Recycled content	60% min
Dimensions	1220 x 2800mm Custom size available upon request
Thickness	24mm +/- 10%

Guarantees

Warranty against defects	20 years*
Light fastness warranty	20 years*

*conditions apply

QuickShip



Talk to our team on our QuickShip lead times

Technical Data

Fire rating	AS/ISO 9705.1, Group 1 ASTM E84-17a, Class A EN 13501-1: 2019, B-s1, d0
Indoor air quality	SCS-EC10.3-2014 v4.0 meeting standard CDPH/EHLB Standard Method v.1.2-2017, $\leq 0.5\text{mg}/\text{m}^3$
Light fastness	ISO 105-B02, 6-7

Sustainability



Made from 60% min. recycled content



Red List Free Declare Label

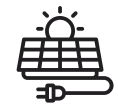

Generated using 40% solar energy



Recyclable at end-of-life



Total VOC's less than $0.5\text{mg}/\text{m}^3$ (3rd Party Verified)



Phenol & formaldehyde free



Acoustic Performance

Test method	ISO 354-2006
Results	NRC 0.60 (no air gap)

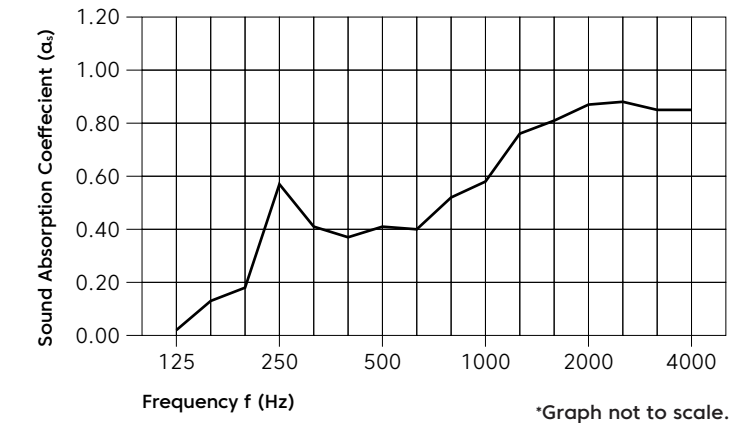

Frequency (Hz)	125	250	500	1000	2000	4000	NRC
α_s	0.02	0.57	0.41	0.58	0.87	0.85	0.60

Colorways

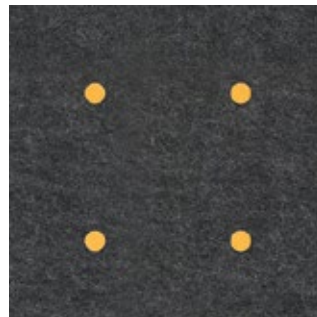

Charcoal + Butter

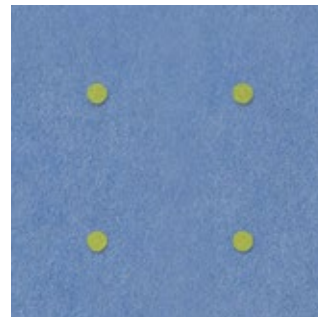

Marine + Wasabi

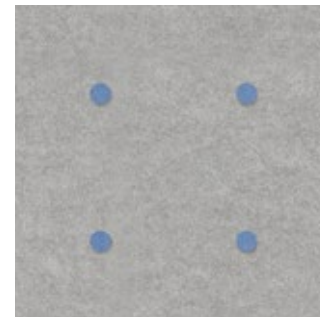

Metal + Marine



Pearl + Wasabi

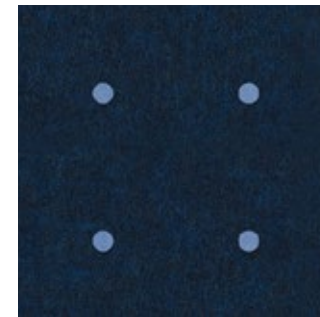

Midnight + Marine

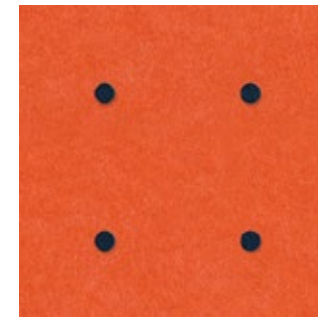

Carrot + Midnight

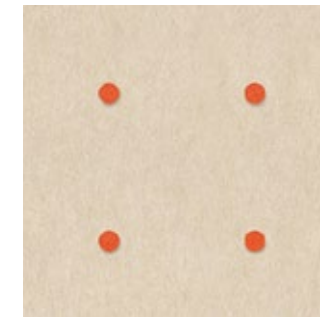

Pearl + Carrot

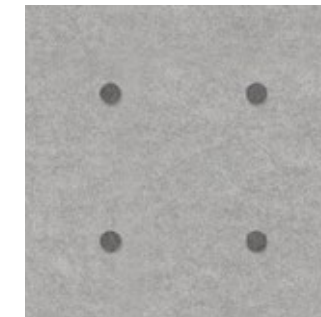

Metal + Slate



Carrot + Charcoal

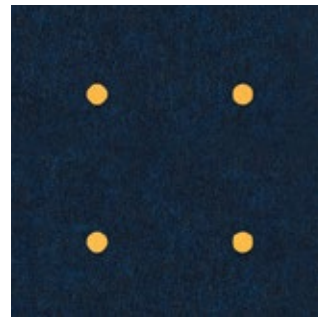

Midnight + Butter

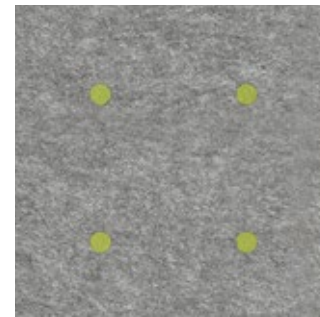

Grey + Wasabi

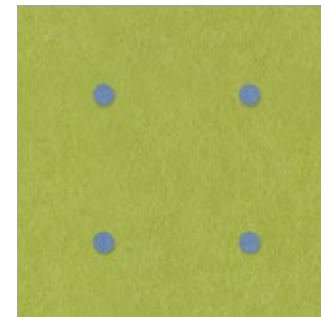

Wasabi + Marine

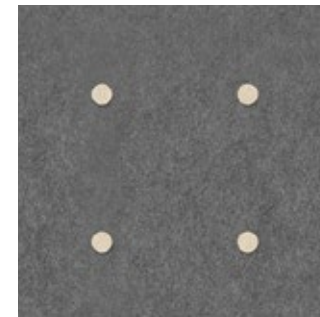

Slate + Pearl

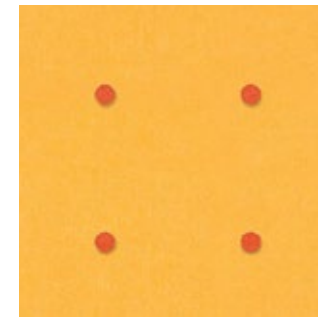

Butter + Carrot

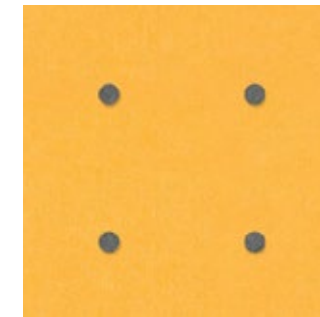

Butter + Slate

Custom colorways and combinations available on request

Mounting Methods

Adhesive Backing

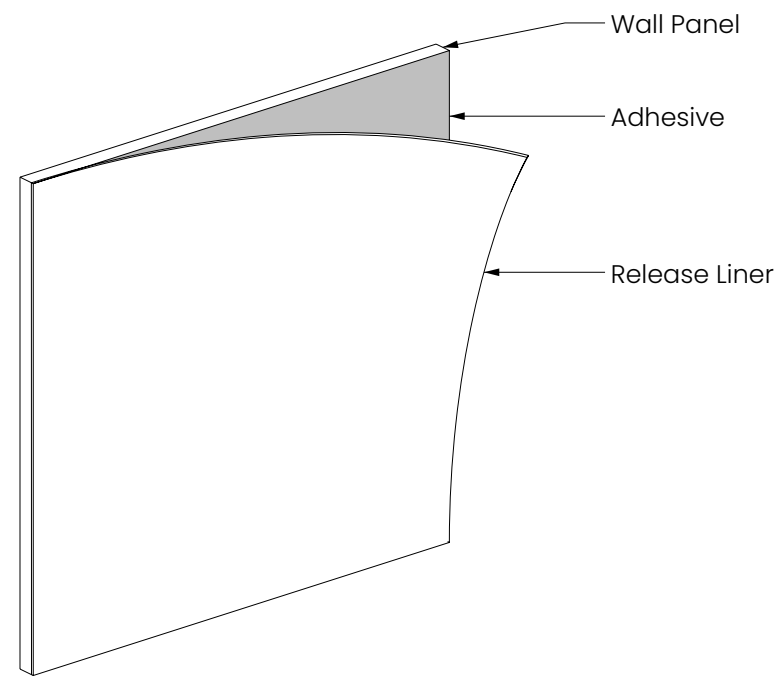

Constructive Adhesive

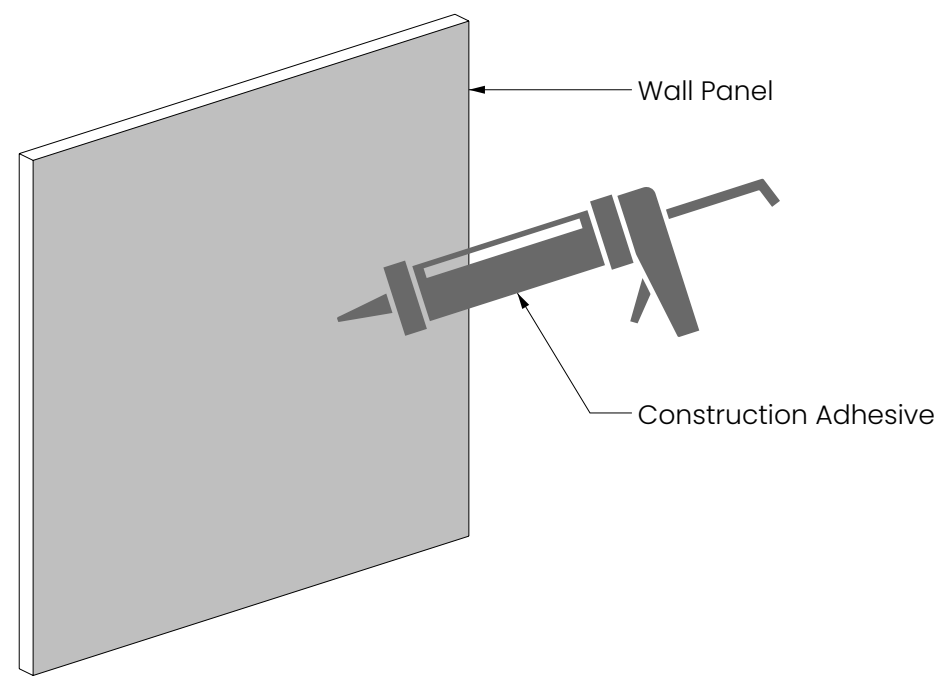

Pot Magnet Install

Wall Pot Magnet Install Metal Plate

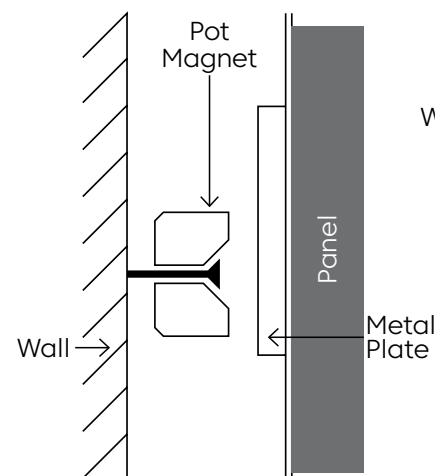

Wall Pot Magnet Install L Plate + Metal Plate

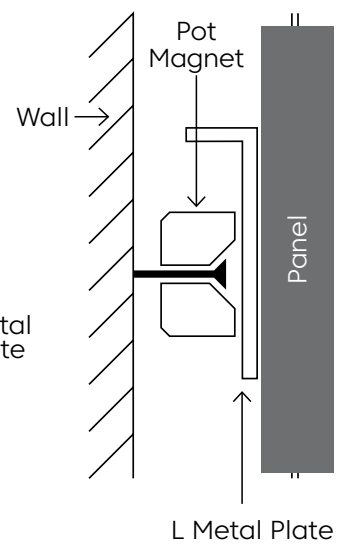

L Plate Wall + Metal Plate Configuration

○ L Metal Plate × Metal Plate

