



Pixel

FilaSorb™ 24

acoufelt
making quiet

Product Detail

Application	Wall
Composition	100% polyester
Material	FilaSorb™
Recycled content	60% min
Dimensions	1200 x 2780mm Custom size available upon request
Thickness	24mm +/- 10%

Guarantees

Warranty against defects 20 years*
Light fastness warranty 20 years*
*conditions apply

QuickShip

QuickShip Standard (Made to Order)



Our standard made to order products have an approx. **2-3 week** lead time from payment and order confirmation.

Technical Data

Fire rating	AS/ISO 9705.1, Group 1 ASTM E84-17a, Class A EN 13501-1: 2019, B-s1, d0
Indoor air quality	SCS-EC10.3-2014 v4.0 meeting standard CDPH/EHLB Standard Method v.1.2-2017, ≤ 0.5mg/m ³
Light fastness	ISO 105-B02, 6-7

Sustainability



Made from 60% min. recycled content



Red List Free Declare Label

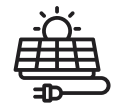

Generated using 40% solar energy



Recyclable at end-of-life



Total VOC's less than 0.5 mg/m³ (3rd Party Verified)



Phenol & formaldehyde free

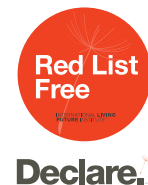

Acoustic Performance

Test method ISO 354-2006
Results NRC 0.60 (no air gap)

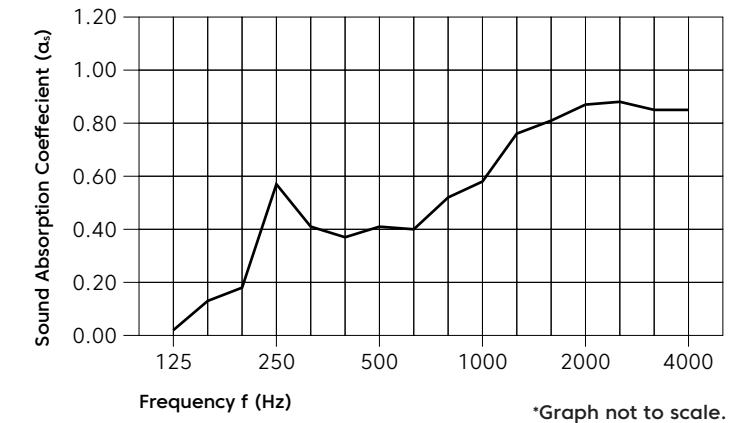

Frequency (Hz)	125	250	500	1000	2000	4000	NRC
αs	0.02	0.57	0.41	0.58	0.87	0.85	0.60

Colorways

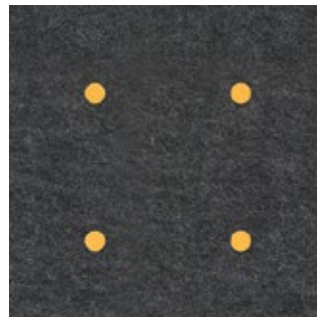

Charcoal + Butter

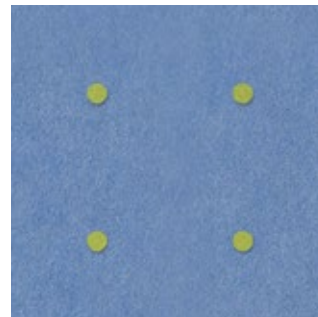

Marine + Wasabi

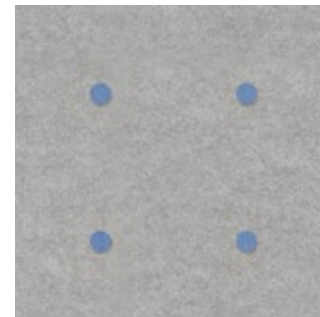

Metal + Marine

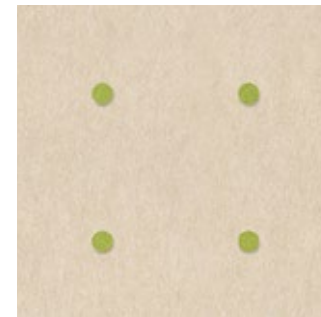

Pearl + Wasabi

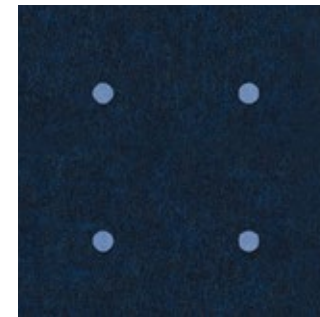

Midnight + Marine

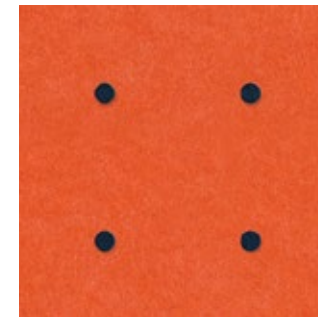

Carrot + Midnight

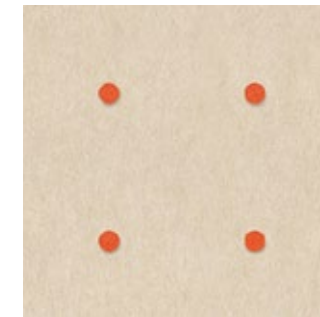

Pearl + Carrot

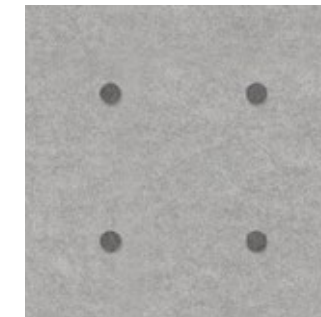

Metal + Slate

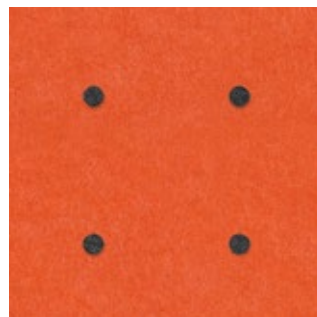

Carrot + Charcoal

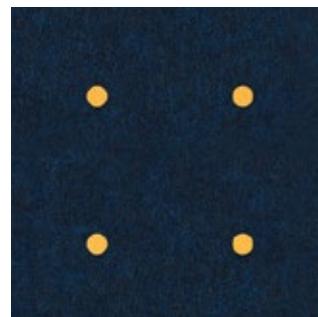

Midnight + Butter

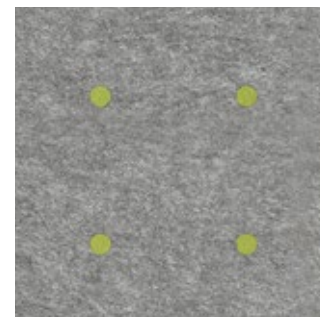

Grey + Wasabi

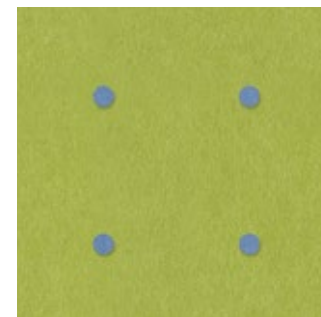

Wasabi + Marine

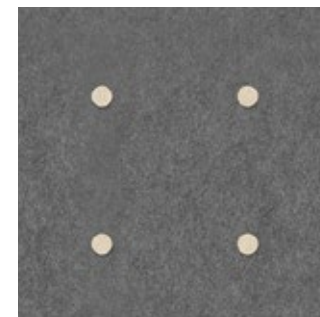

Slate + Pearl

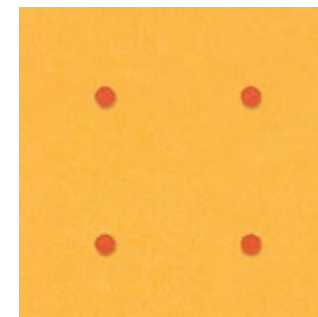

Butter + Carrot

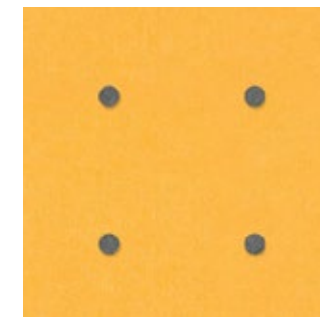

Butter + Slate

Custom colorways and combinations available on request

Mounting Methods

Adhesive Backing

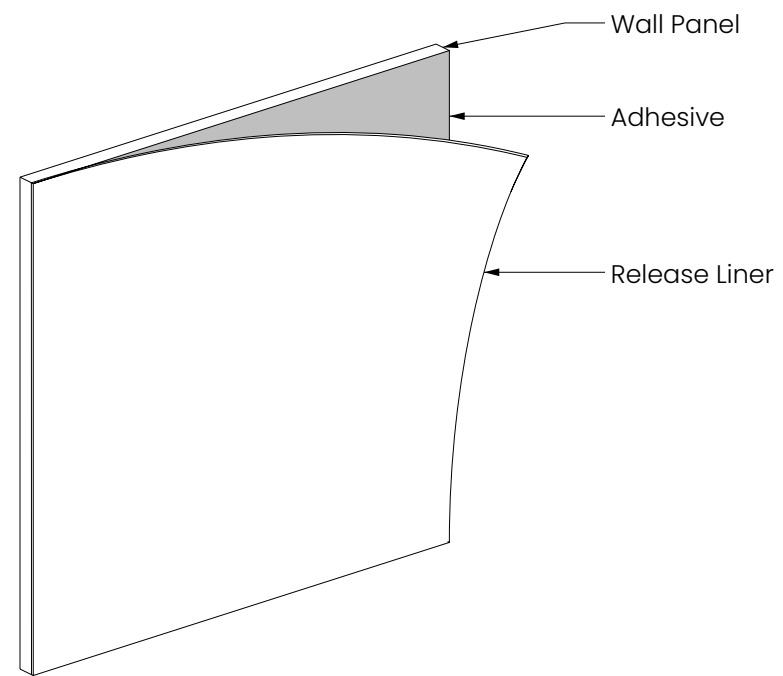

Constructive Adhesive

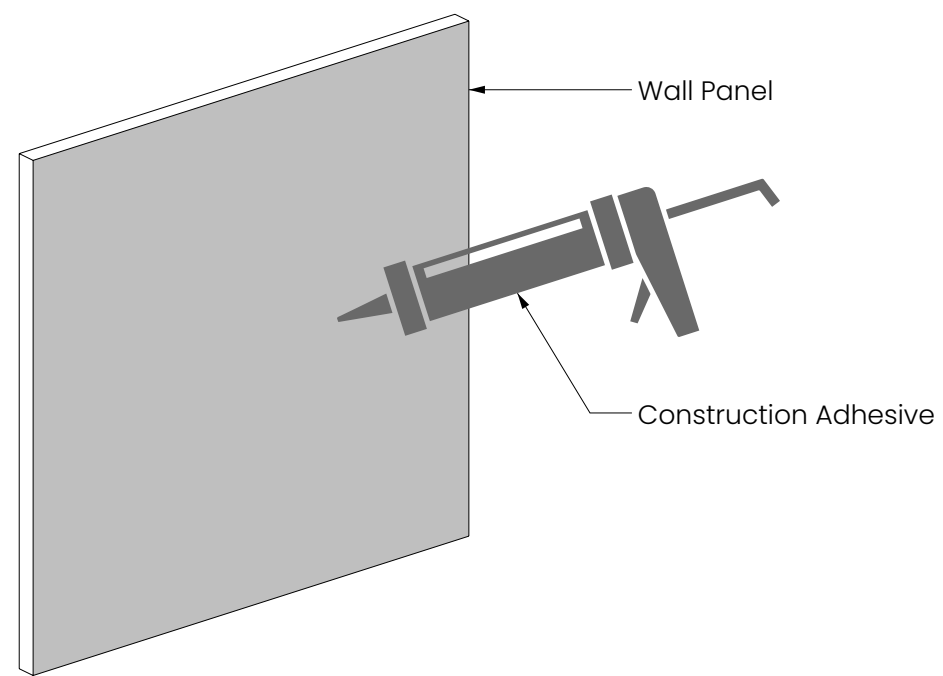

Pot Magnet Install

Wall Pot Magnet Install Metal Plate

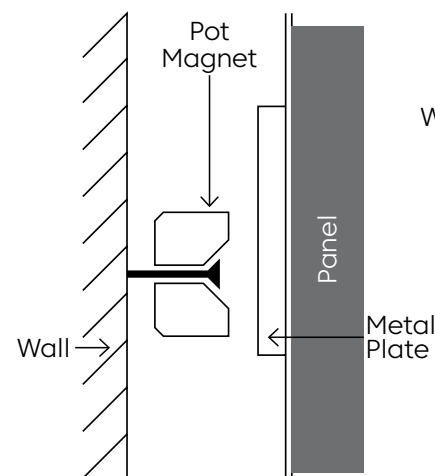

Wall Pot Magnet Install L Plate + Metal Plate

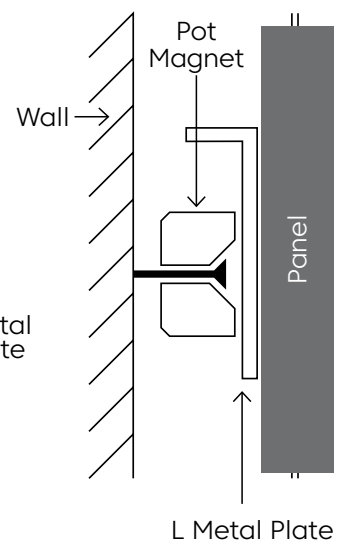

L Plate Wall + Metal Plate Configuration

○ L Metal Plate × Metal Plate

