



Skipping Stones Ceiling Clouds

WoodGrain Collection

Skipping Stones is a collection of sculptural clouds that captivate the eye and transform its surroundings. Ideal for expansive, open areas, these clouds command attention while maintaining a sense of lightness. Gently rounded edges soften their grand presence, creating an inviting, almost floating effect that adds depth and dimension to any space. The interior is softly detailed, offering a refined look that can be enhanced with optional integrated lighting. Available in five distinct models, each design can stand alone or be hung in multiples to form a luminous, floating centerpiece that elevates any environment.

Specifications

Surface	Ceiling
Material	FilaSorb™ polyester felt
Weight	2400 gsm
Standard Sizes	Heights: 254, 508mm H Widths: 686, 991, 1016, 1219mm W Lengths: 954, 1219, 1575, 1600, 2438mm L



Skipping Stones Ceiling Clouds in Mountain Lodge with Lighting

Technical

NRC Rating	1.90*
Fire Test	Test Results Pending
Water Sorption	ASTM C1104-2019 (A Modified) Water sorbed by weight: 0.20% (based on a 12mm thick panel)
Colorfastness	ISO 105-B02, 6-7

* Rating is estimated based on similar product designs. Comparison NRC results available upon request.

Details

Lead Time	Refer to Product Lead Time Matrix
Origin	Australia
Warranty	Product: 20 years* Colorfastness: 20 years*

* Conditions apply

Environmental

Recycled Content	Minimum 60%
Energy	Generated using 40% solar energy
Indoor Air Quality	VOC less than/equal to 0.5mg/m3
Recyclable	100%*
Certifications	Declare Certification - LBC Red List Free (third-party verified) SCS Global Indoor Advantage Gold

* PET is recyclable through participating partners.



For questions or additional product information, visit acoufelt.com.au or call 1800 626 462

Skipping Stones Ceiling Clouds | April 2026

Colorways

WOODGRAIN



Picket Fence
WQ01



Loft
WQ06



White Elm
WQ07



Lyed Larch
WQ30



White Oak
WQ13



Baltic Birch
WQ12



Knotty Spruce
WQ29



French Bobbin
WQ08



Boat Shed
WQ02

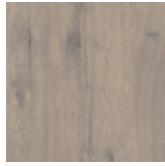

Nordic Plank
WQ15

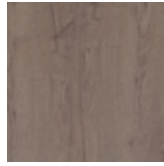

Boardwalk
WQ10

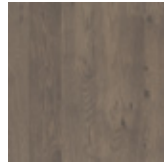

Mocha Legno
WQ25



Mountain Lodge
WQ24

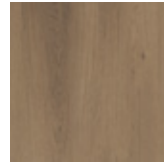

Wine Barrel
WQ03

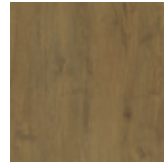

Log Cabin
WQ04



Natural Oak
WQ16



Woodland Fog
WQ22



Driftwood
WQ21



Weathered Slate
WQ14



Petrified Ash
WQ23

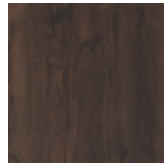

Antique Chest
WQ11



European Larch
WQ17

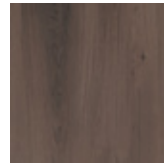

Fumed Oak
WQ19

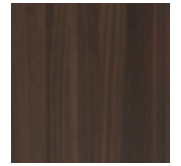

Teak
WQ18



Charred Larch
WQ09



Shadow Oak
WQ28

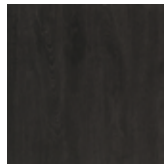

Barn Door
WQ05

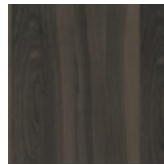

Black Walnut
WQ20



Scorched Timber
WQ26



Espresso Oak
WQ27



For questions or additional product information,
visit acoufelt.com.au or call 1800 626 462

Sizes

Standard Sizes Height: 254, 508mm H
 Widths: 686, 991, 1016, 1219mm W
 Lengths: 956, 1219, 1575, 1600, 2438mm L

Plans

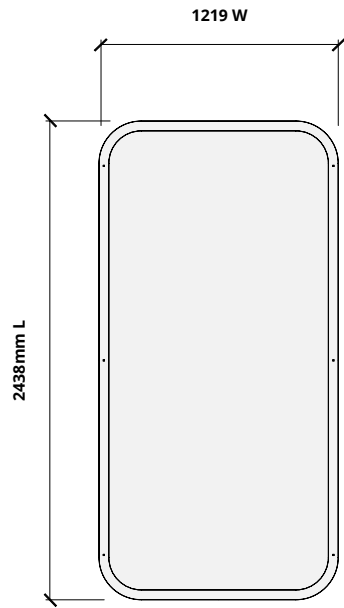

SKIPPING STONE A

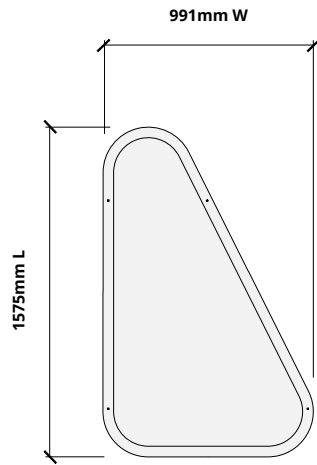

SKIPPING STONE B

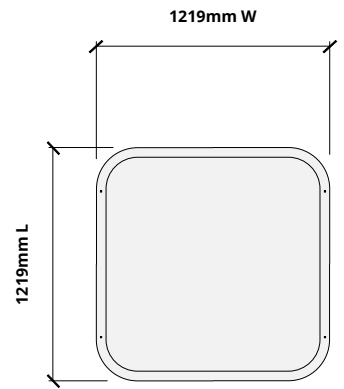

SKIPPING STONE C

Elevations

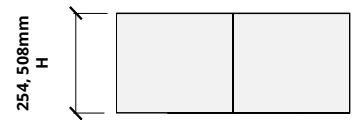
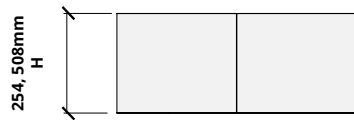

Perspectives

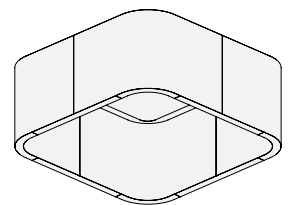
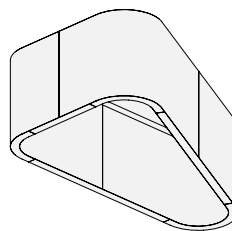
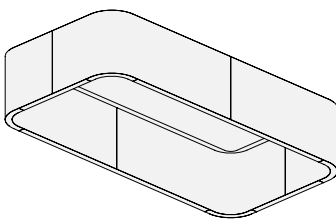

Models can be mixed and matched to create a desired pattern.

Sizes (cont.)

Plans

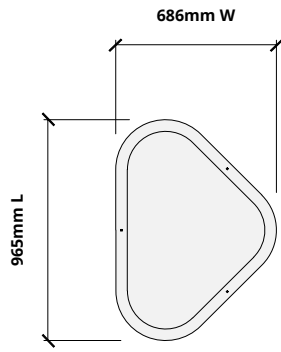

SKIPPING STONE D

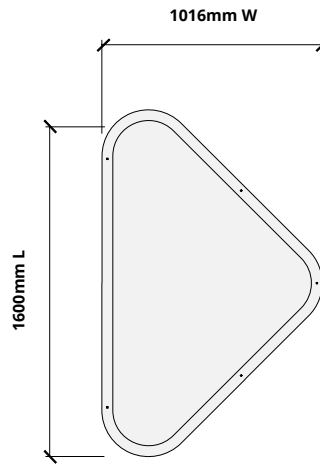

SKIPPING STONE E

Elevations

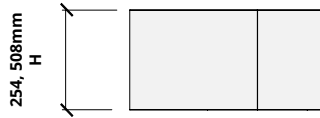
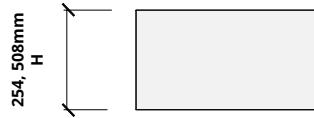

Perspectives

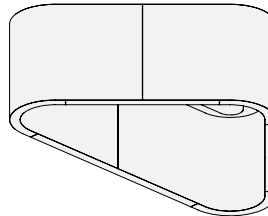
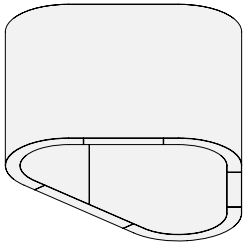

Models can be mixed and matched to create a desired pattern.

How to Specify

1. Choose Model

2. Choose Height

3. Choose Colorways

Skipping Stones Clouds are available in 5 models. You can mix and match the models to create your overall design.

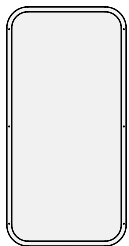

Skipping Stone A

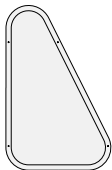

Skipping Stone B

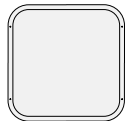

Skipping Stone C



Skipping Stone D

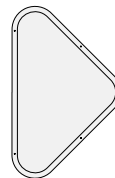

Skipping Stone E

1. Choose Model

2. Choose Height

3. Choose Colorways

Clouds are available in two heights: 254mm and 508mm. Multiple heights can be selected based on the overall desired design.

1. Choose Model

2. Choose Height

3. Choose Colorways

Select one or multiple colorways to achieve the overall desired design. See colorway choices on pages 3 and 4.



For questions or additional product information, visit acoufelt.com.au or call 1800 626 462

Skipping Stones Ceiling Clouds | April 2026

Mounting Methods

Cable

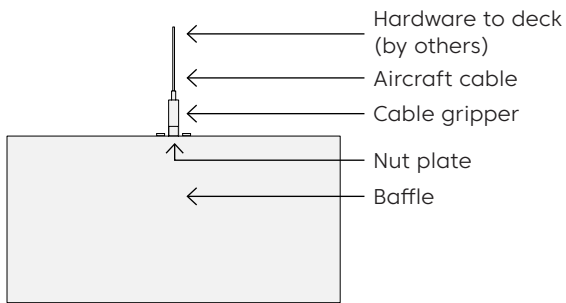

Cable to deck

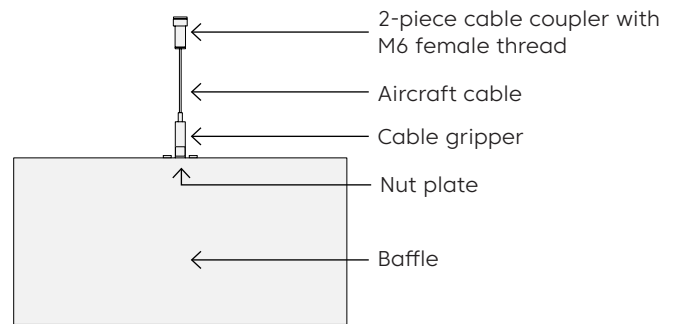

Threaded rod

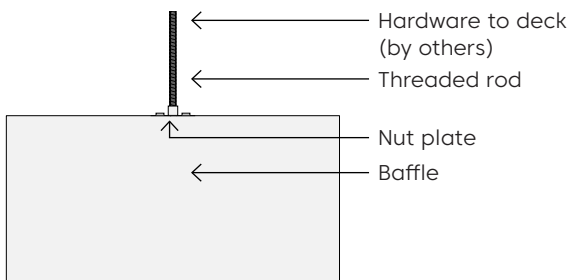

Acoustic Performance

Test Method	ASTM C423-17
Install Method	Type A
Rating Method	ISO 11654-2007
Test Results	NRC 1.90

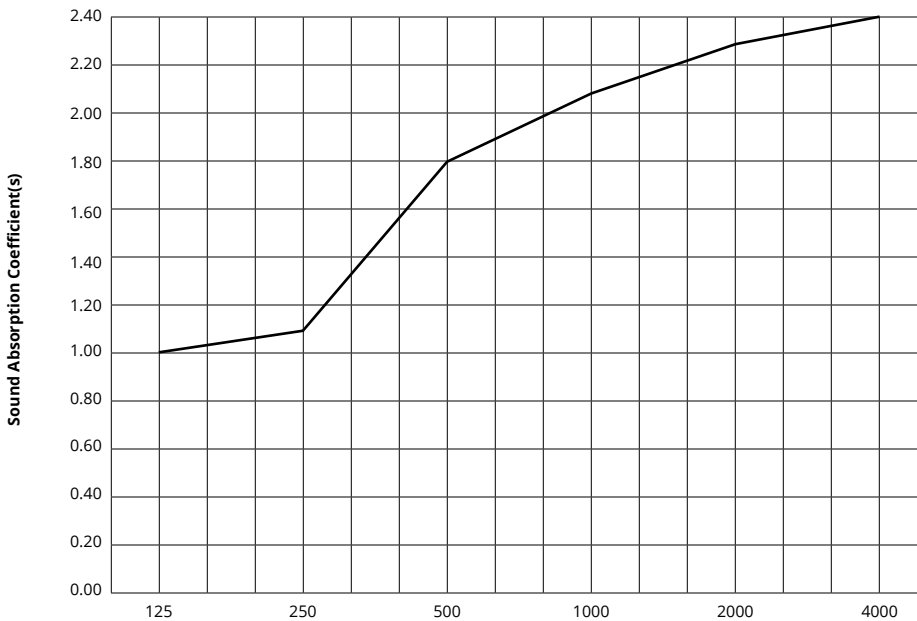

Frequency f (Hz)	125	250	500	1000	2000	4000	NRC
12mm	1.00	1.30	1.80	2.10	2.30	2.40	1.90

What is a Noise Reduction Coefficient (NRC)?

You'll find the NRC rating in the specifications of all of our products. This acronym stands for Noise Reduction Coefficient, and is expressed as a single number, a rating that describes the degree to which acoustic products can absorb sound.

You can use NRC values to understand the overall performance of our acoustic wall and ceiling products. The higher the NRC, the better the product is at soaking up the sound.

Performance Indices: Noise Reduction Coefficient (NRC) results represent the absorption coefficients measured at the one third octave bands at 125, 250, 500, 1000, 2000 and 4000 Hz rounded to the nearest 0.05. Acoustic testing has been performed according to the methods mentioned above. Customization of installation of the product could alter the results. Sound Absorption Average (SAA) indicates the absorption coefficient average for the twelve one-third octave bands ranging between 200 and 2500 Hz.

 For questions or additional product information, visit acoufelt.com.au or call 1800 626 462

Skipping Stones Ceiling Clouds | April 2026